

TT 2-A II

ACTIVE TWO-WAY SPEAKER

DESCRIPTION

With 134 dB SPL power, extreme linearity and low distortion in a vented two-way enclosure, the active RCF TT 2-A speaker is one of the most flexible speakers in its category. Though compact and lightweight, the TT 2-A offers the signature high-end TT+ sound quality with a two-channel 1600 W RMS Class-D amplifier, FiRPHASE 0° linear phase response DSP, RDNet networked control, rugged hardware and a complete set of rigging options.



FEATURES

- 134 dB max SPL
- 1600 W Class-D two-channel amplifier
- 90° x 50° constant directivity coverage
- FiRPHASE for 0° phase response
- Heavy-duty touring cabinet
- 32 bit - 96 kHz processing

TECHNICAL SPECIFICATIONS

Acoustical specifications	Frequency Response:	50 Hz ÷ 20000 Hz
	Max SPL @ 1m:	134 dB
	Horizontal coverage angle:	90°
	Vertical coverage angle:	50°
Transducers	Compression Driver:	1 x 1.4" neo, 3.0" v.c
	Woofers:	12" neo, 4.0" v.c
Input/Output section	Input signal:	bal/unbal
	Input connectors:	XLR
	Output connectors:	XLR
	Input sensitivity:	+4 dBu
Processor section	Crossover Frequencies:	750 Hz
	Protections:	Thermal, RMS
	Limiter:	Soft Limiter
	Controls:	Gain reduction, RDNet local setup/bypass, Time Delay, Presets (Linear, Close, Far listening, High-pass), RDNet on board
	RDNet:	Yes
Power section	Total Power:	3200 W Peak, 1600 W RMS
	High frequencies:	1000 W Peak, 500 W RMS
	Low frequencies:	2200 W Peak, 1100 W RMS
	Cooling:	Convection
	Connections:	Powercon IN/OUT
Standard compliance	CE marking:	Yes
Physical specifications	Cabinet/Case Material:	Baltic birch plywood
	Hardware:	Installation/Rental fittings
	Handles:	2 side
	Pole mount/Cap:	Yes
	Grille:	Steel
	Color:	Black
Size	Height:	643 mm / 25.31 inches
	Width:	372 mm / 14.65 inches
	Depth:	470 mm / 18.5 inches
	Weight:	34.4 kg / 75.84 lbs
Shipping informations	Package Height:	900 mm / 35.43 inches
	Package Width:	580 mm / 22.83 inches
	Package Depth:	490 mm / 19.29 inches
	Package Weight:	37.8 kg / 83.33 lbs



PART NUMBER

- **13000629**

TT 2-A II

115V

EAN 8024530018078

- **13000628**

TT 2-A II





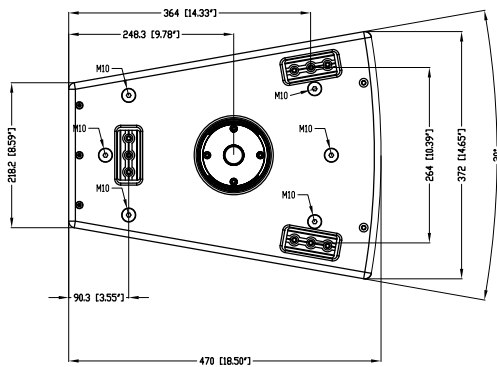
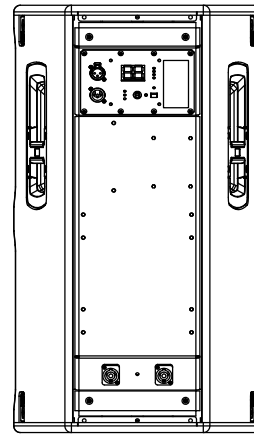
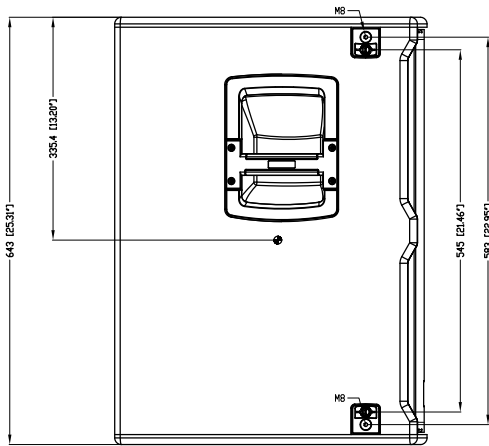
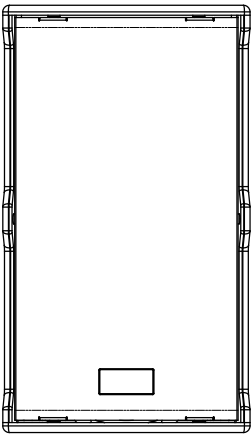
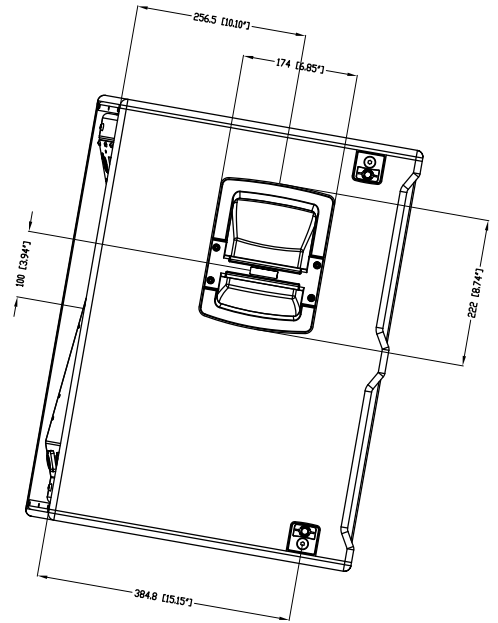
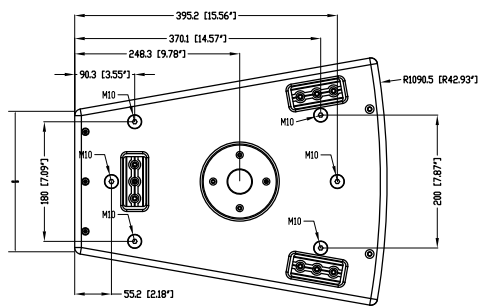



220-240V

EAN 8024530018061



TT2-A

ACCESSORIES

	AC PMA - POLE MOUNT	PART NUMBER EAN:	13360034 8024530007713
	AC PM-M20	PART NUMBER EAN:	13360067 8024530014599
	AC PMX POLE MOUNT M20	PART NUMBER EAN:	13360232 8024530010058
	AC PRO-FS PROFESS. LOCKING FLOOR STAND	PART NUMBER EAN:	13360109 8024530006471
	AC PRO-PM PROFESS. LOCKING POLE MOUNT	PART NUMBER EAN:	13360110 8024530006488
	COVER CVR TT 2	PART NUMBER EAN:	13360245 8024530013806
	DOUBLE STUD 4X	PART NUMBER EAN:	13360030
	END BRACKET FOR CHAIN 2X AC TT2 END PL	PART NUMBER EAN:	13360262
	HORIZONTAL BRACKET H-BR TT 2	PART NUMBER EAN:	13360259 8024530016531



KIT EYEBOLT 4 X

PART NUMBER **13360031**
EAN:



VERTICAL BRACKET V-BR TT 2

PART NUMBER **13360260**
EAN: 8024530016869
